

QUICK INSTALLATION GUIDE



GAMDIAS
AEOLUS | M1
1205R
Case & Radiator Fan

Package Contents

A

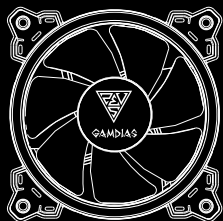

x5

B

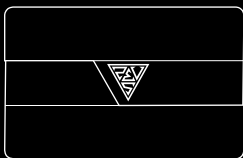

x1

C



x1

D

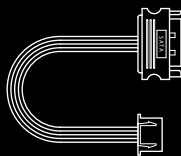

x1

E



x1

F



x1

G



x 20

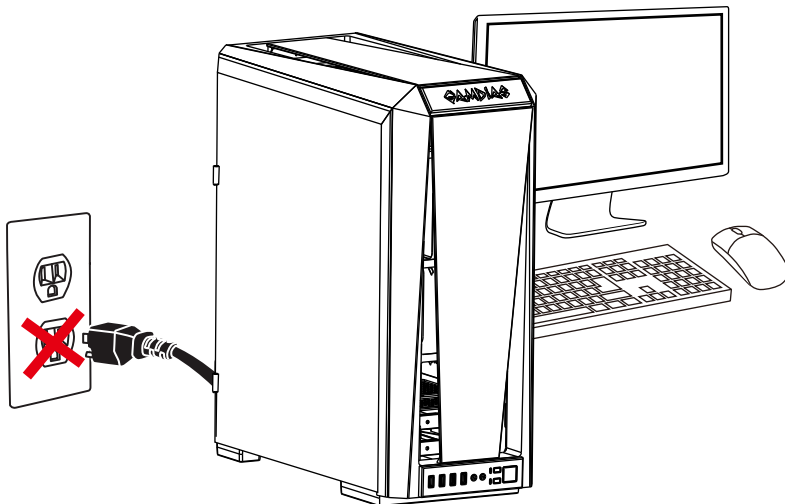

English

- ♦ Make sure that your system is turned off and unplugged.

Français

- ♦ Assurez-vous que le système est éteint et débranché.

Русский

- ♦ Убедитесь, что система выключена и отключена от электросети.

Deutsch

- ♦ Stellen Sie sicher, dass Ihr System ausgeschaltet und alle Stromkabel gezogen sind.

Español

- ♦ Asegúrese de que el sistema está apagado y desenchufado.

Italiano

- ♦ verificare che il sistema sia spento e scollegato.

Português

- ♦ Certifique-se que o seu sistema está desligado e sem corrente eléctrica.

Türk dili

- ♦ Sisteminizin kapalı olduğundan ve fişinin takılı olmadığından emin olun.

01

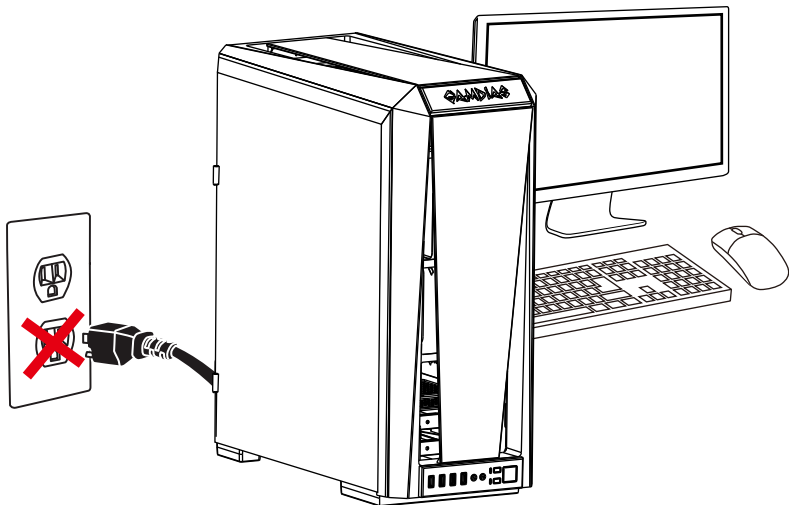

日本語

- ◆ システムがオフになっており、プラグを抜いていることを確認してください。

繁體中文

- ◆ 請確定系統已關閉且已斷電。

ภาษาไทย

- ◆ ตรวจสอบให้แน่ใจว่าคุณได้ปิดระบบของคุณและถอดปลั๊กออกแล้วถอดสายไฟฟ้า

简体中文

- ◆ 请确保系统已关闭，并已拔出插头。

02

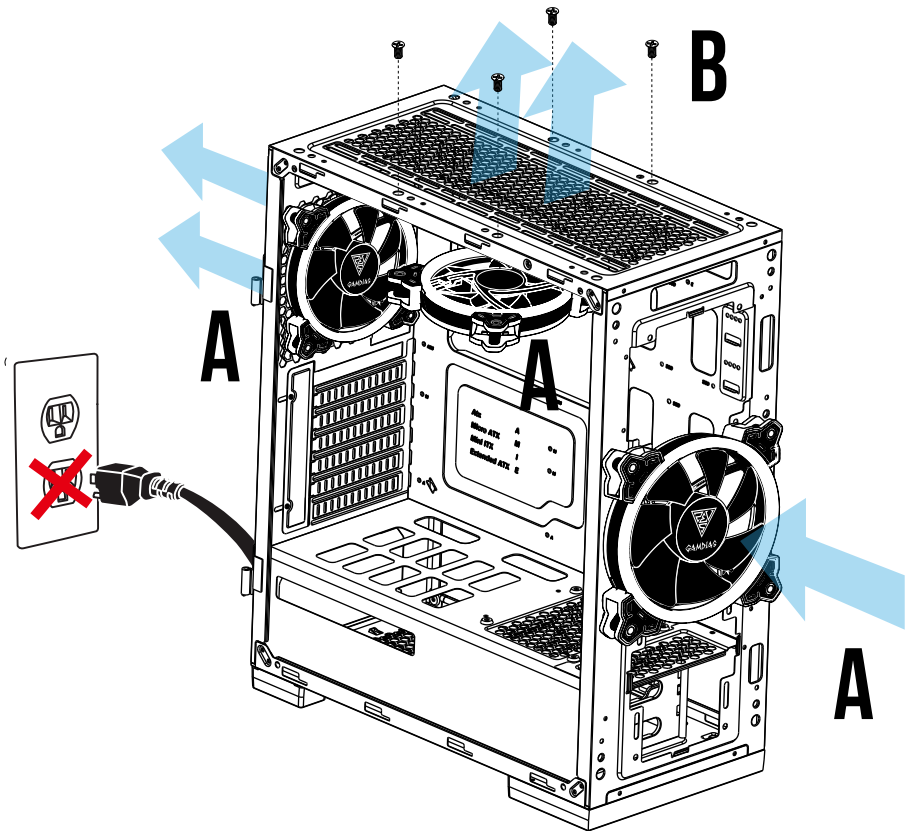

03

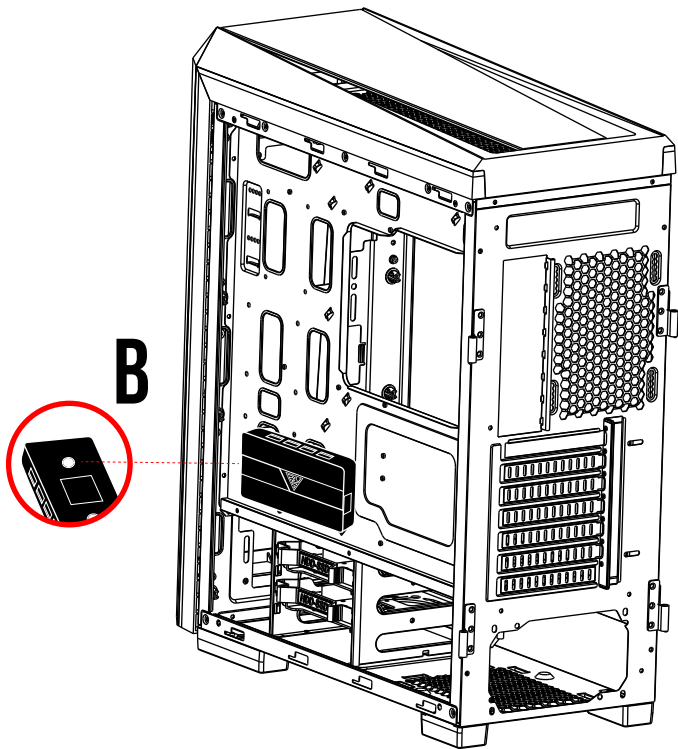

04

Fans must start at "FAN1" and continue in series.
FAN1 → FAN2 → FAN3 → FAN4 → FAN5 → FAN6

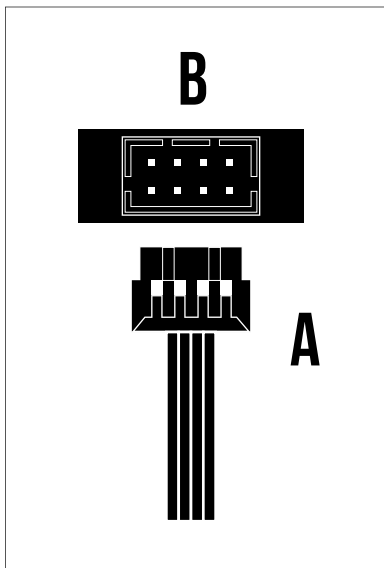
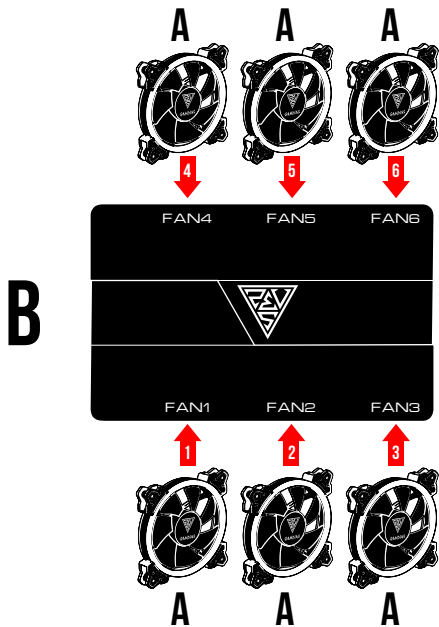

04

English

- ◆ Fans must start at "FAN1" and continue in series.
FAN1 → FAN2 → FAN3 → FAN4 → FAN5 → FAN6
- ◆ Any fan not connected in series will break communication and the RGB lighting function will not work.

Español

- ◆ Los ventiladores deben comenzar en "FAN1" y continuar en serie.
FAN1 → FAN2 → FAN3 → FAN4 → FAN5 → FAN6
- ◆ Cualquier ventilador no conectado en serie romperá la comunicación y no se activará la función de iluminación RGB

Deutsch

- ◆ Lüfter müssen bei „FAN1“ beginnen und in Reihe fortgesetzt werden.
FAN1 → FAN2 → FAN3 → FAN4 → FAN5 → FAN6
- ◆ Jeder nicht in Reihe geschaltete Lüfter unterbricht die Kommunikation und die RGB-Beleuchtung funktioniert nicht

Polski

- ◆ Wentylatory muszą uruchamiać się przy „FAN1” i kontynuować działanie szeregowo.
FAN1 → FAN2 → FAN3 → FAN4 → FAN5 → FAN6
- ◆ Wentylator, który nie jest podłączony szeregowo przerwie komunikację i funkcja oświetlenia RGB nie będzie działać

Français

- ◆ Les ventilateurs doivent commencer à "FAN1" et continuer en série.
FAN1 → FAN2 → FAN3 → FAN4 → FAN5 → FAN6
- ◆ Les ventilateurs non connectés en série rompent la communication et empêchant le fonctionnement de l'éclairage RVB

Svensk

- ♦ Fläktar måste starta på "FAN1" och fortsätta i serie.
FAN1 → FAN2 → FAN3 → FAN4 → FAN5 → FAN6
- ♦ Fläktar som inte ansluts i serie kommer att bryta kommunikationen och RGB-belysningsfunktionen kommer inte att fungera

Italiano

- ♦ Le ventole devono partire da "FAN1" e continuare in serie.
FAN1 → FAN2 → FAN3 → FAN4 → FAN5 → FAN6
- ♦ Qualsiasi ventola non collegata in serie interrompe la comunicazione e la funzione di illuminazione RGB non funziona

Português

- ♦ As ventoinhas devem começar em "FAN1" e continuar em série.
FAN1 → FAN2 → FAN3 → FAN4 → FAN5 → FAN6
- ♦ Qualquer ventoinha não conectada em série interromperá a comunicação e a função de iluminação RGB não funcionará

Русский

- ♦ Вентиляторы запускаются с «FAN1» и далее по порядку.
FAN1 → FAN2 → FAN3 → FAN4 → FAN5 → FAN6
- ♦ Если какой-либо из вентиляторов не подключен последовательно, связь прерывается, и функция подсветки RGB не работает

العَرَبِيَّة

- ♦ يجب أن تبدأ المراوح من "FAN1" وتستمر على التوالي. FAN6 ← FAN5 ← FAN4 ← FAN3 ← FAN2 ← FAN1
- ♦ إذا لم يتم توصيل أي مروحة على التوالي، فسيتم قطع الاتصال ولن تعمل وظيفة إضاءة RGB

04

Türk dili

- ◆ Fanlar "FAN1" değerinden başlamalı ve sıralı olarak devam etmelidir.
FAN1 → FAN2 → FAN3 → FAN4 → FAN5 → FAN6
- ◆ Sıralı olarak bağlanmayan herhangi bir fan iletişimi kesecek ve RGB aydınlatma işlevi çalışmayacaktır.

日本語

- ◆ ファンは「FAN1」で始まり、順に続くようにしてください。
FAN1 > FAN2 > FAN3 > FAN4 > FAN5 > FAN6
- ◆ ファンが順につながれていない場合、連携が切断され、RGB照明効果が機能しません。

한국어

- ◆ 팬은 "FAN1"에서 시작해 순서대로 이어져야 합니다. FAN1 > FAN2 > FAN3 > FAN4 > FAN5 > FAN6
- ◆ 순서대로 연결되지 않은 팬은 신호가 끊겨 RGB 라이트 기능이 작동하지 않습니다.

ภาษาไทย

- ◆ พัดลมจะต้องเริ่มต้นที่ "FAN1" และต่อเนื่องไปเรื่อยๆ ตามลำดับ
FAN1 > FAN2 > FAN3 > FAN4 > FAN5 > FAN6
- ◆ พัดลมที่ไม่เชื่อมต่อกับลำดับจะทำให้การสื่อสารขาดตอน และฟังก์ชันไฟ RGB จะไม่ทำงาน

繁體中文

- ◆ 風扇安裝必需從FAN1開始，並依序插入。FAN1→FAN2→FAN3→FAN4→FAN5→FAN6
- ◆ 若沒依序安裝，會導致燈光功能失效。

简体中文

- ◆ 风扇安装必需从FAN1开始，并依序插入。FAN1→FAN2→FAN3→FAN4→FAN5→FAN6
- ◆ 若没依序安装，会导致灯光功能失效。

05

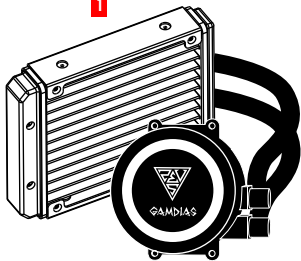
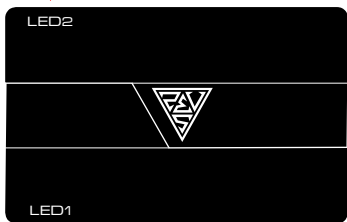
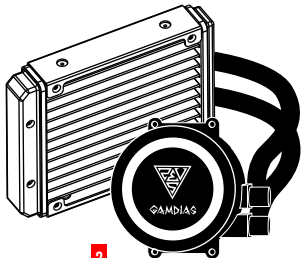

B

B

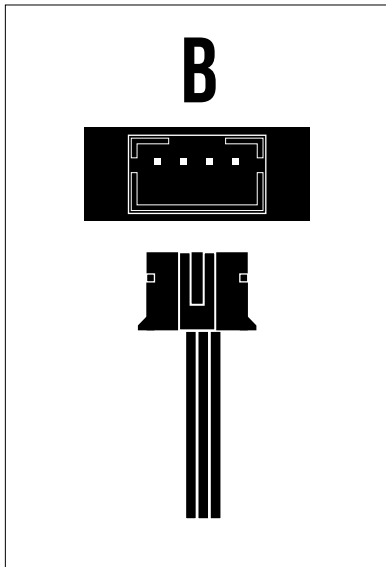
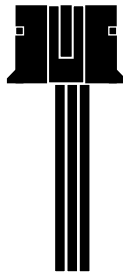
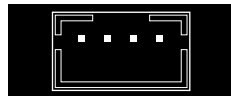



ASUS – AURA Addressable Header

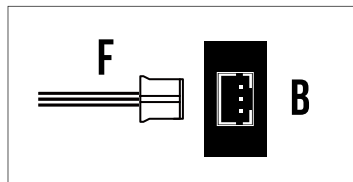
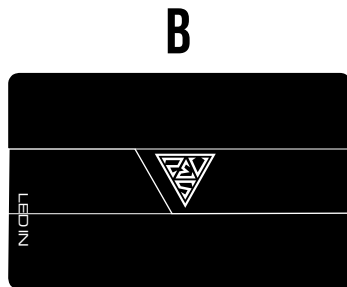
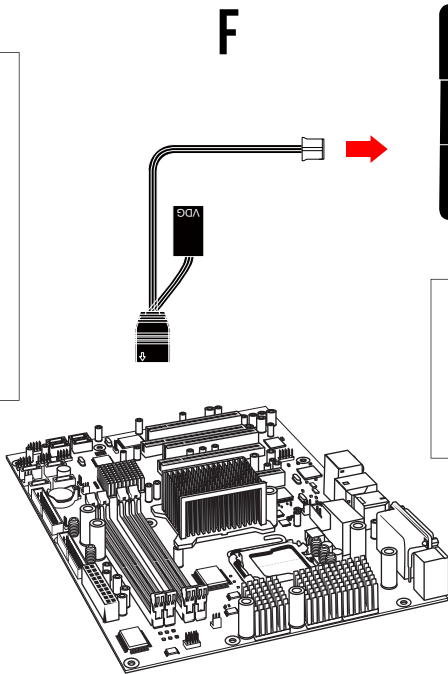
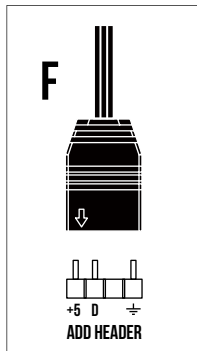

MSI - JRAINBOW Header

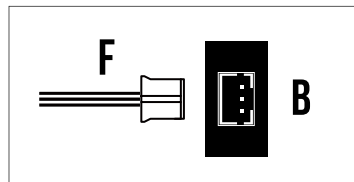
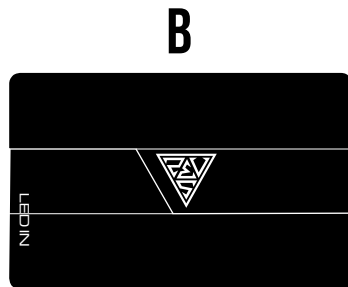
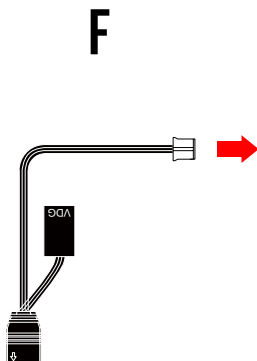
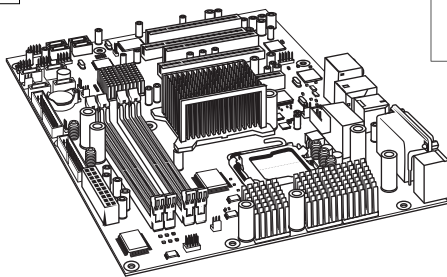
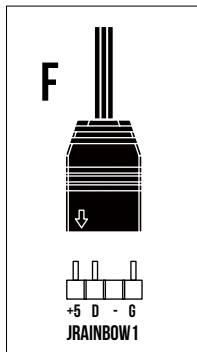



ASRock - Addressable LED Header

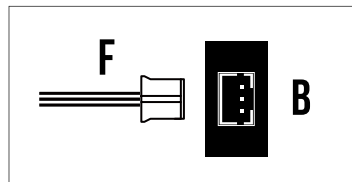
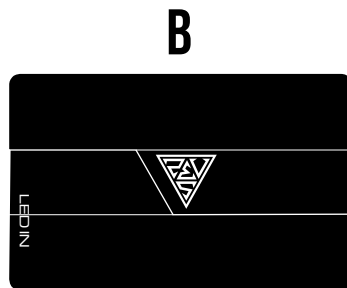
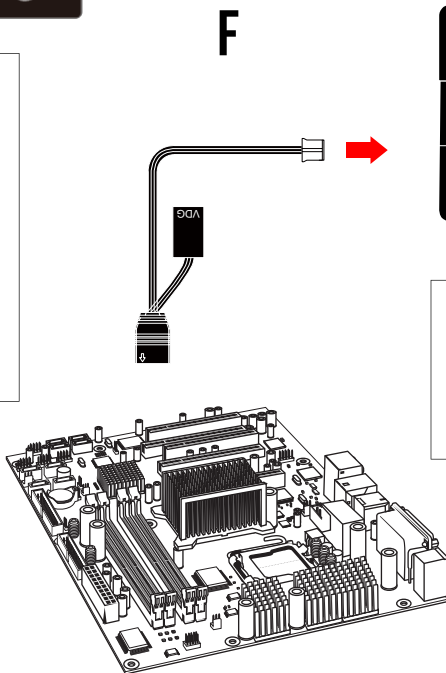
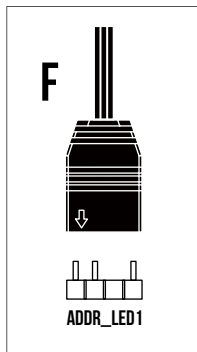



GIGABYTE - Digital LED Header

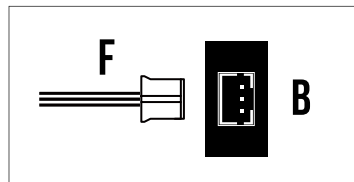
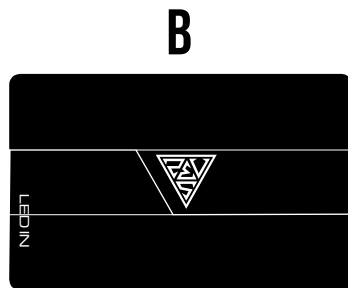
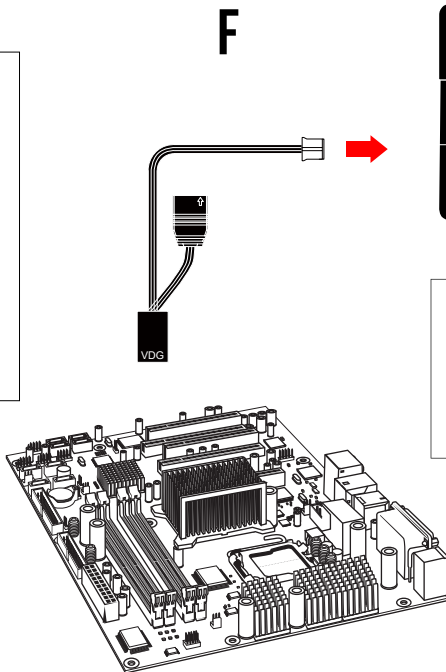
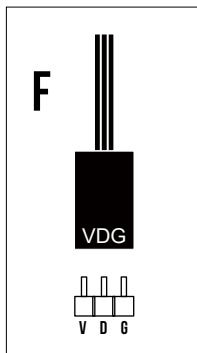

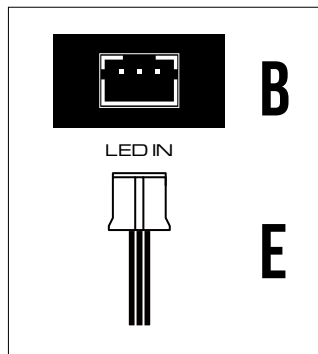
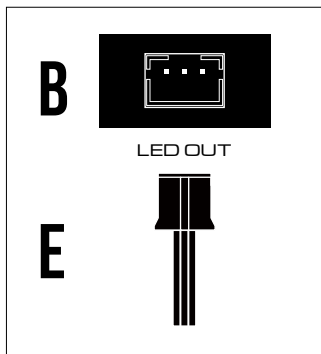
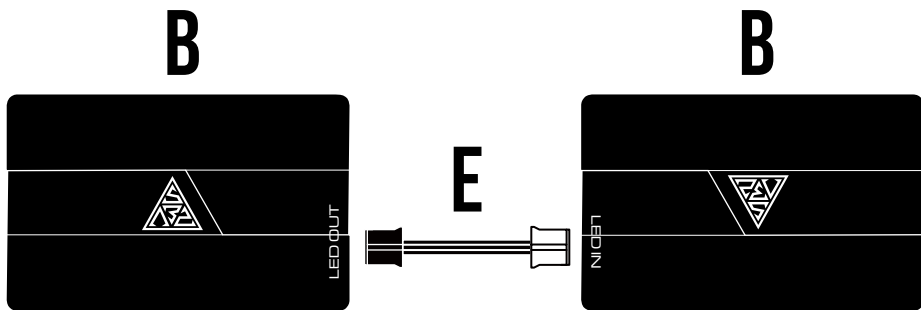

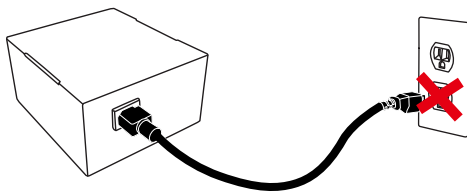
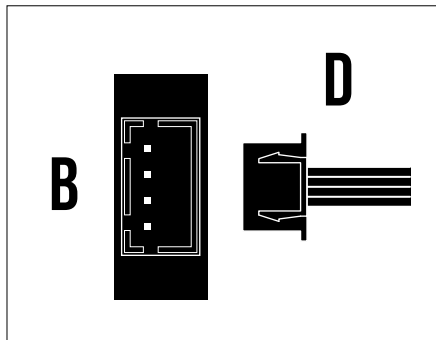
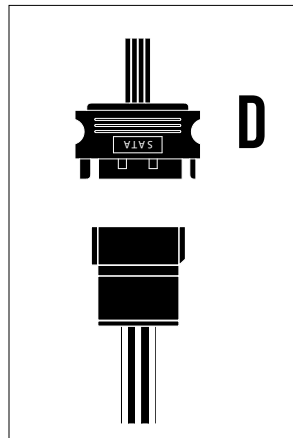
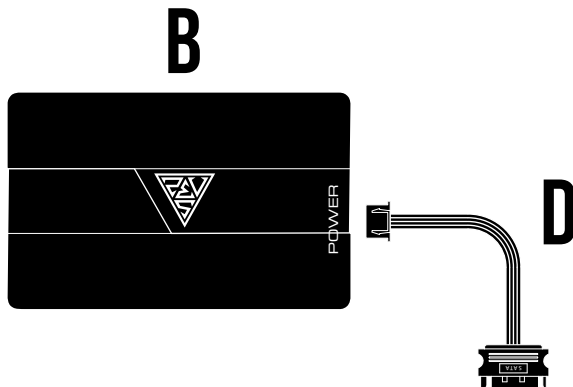



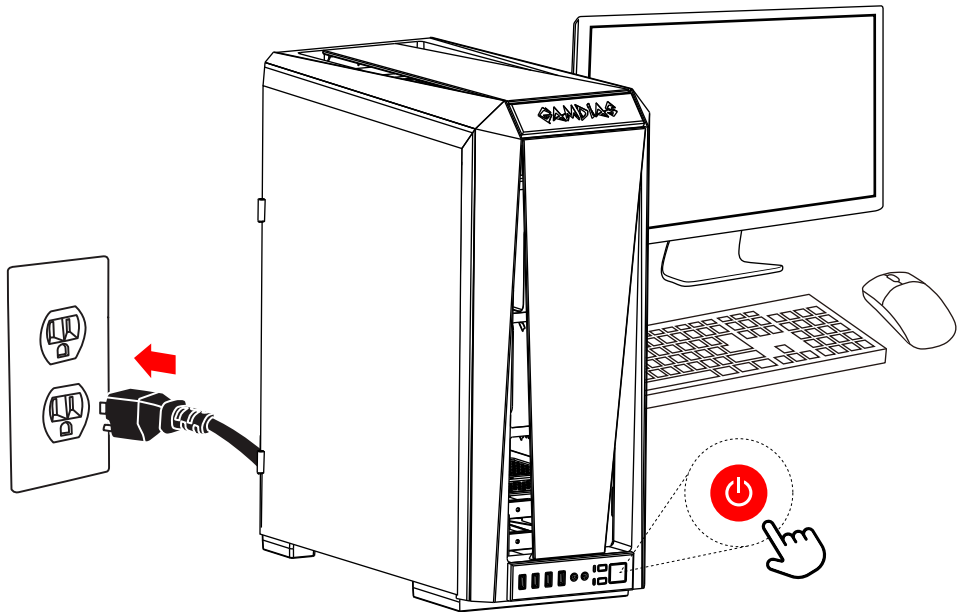















12





-   LED ON/OFF
-  Motherboard Sync
-   Mode
-   Light Speed
-   Fan Speed
-   Brightness
-     Lighting Effect
-   

Product Warranty Policy	http://www.gamdias.com/warranty-en-gb
Política de la garantía del producto	http://www.gamdias.com/warranty-en-gb
Garantiebedingungen	http://www.gamdias.com/warranty-en-gb
Política de garantía do produto	http://www.gamdias.com/warranty-en-gb
Политика по гарантии продукции	http://www.gamdias.com/warranty-en-gb
Quarantie Limitée de Produit	http://www.gamdias.com/warranty-en-gb
Condizioni di Garanzia del Prodotto	http://www.gamdias.com/warranty-en-gb
Garantipolicy	http://www.gamdias.com/warranty-en-gb
Warunki Gwarancji	http://www.gamdias.com/warranty-en-gb
شروط ضمان منتجات	http://www.gamdias.com/warranty-en-gb
製品保証ポリシー	http://www.gamdias.com/warranty-en-gb
產品保固政策	http://www.gamdias.com/warranty-en-gb
产品保固政策	http://www.gamdias.com/warranty-en-gb



GAMDIAS

GAMING ART IN MOTION